

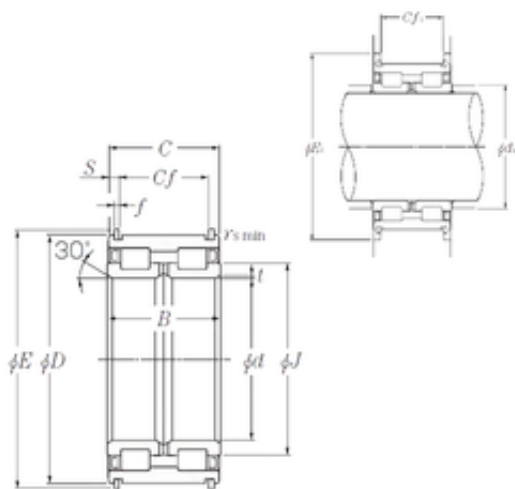

SL04-5084NR NTN Cylindrical Roller Bearing

Bearing No. SL04-5084NR



SL04-5084NR Bearing 2D drawings and 3D CAD models

Size	420x620x272 mm
Bore Diameter	420 mm
Outer Diameter	620 mm
Width	272 mm
d	420 mm
D	620 mm
B	272 mm
C	270 mm
E1	695 mm
t	3,5 mm
f	12 mm
r min.	2 mm
E	647 mm
J	486 mm
S	30 mm
da	432 mm
Cf	210 mm
Cf1	210 mm
Weight	292 Kg
Basic dynamic load rating (C)	4 350 kN
Basic static load rating (C0)	10 300 kN