

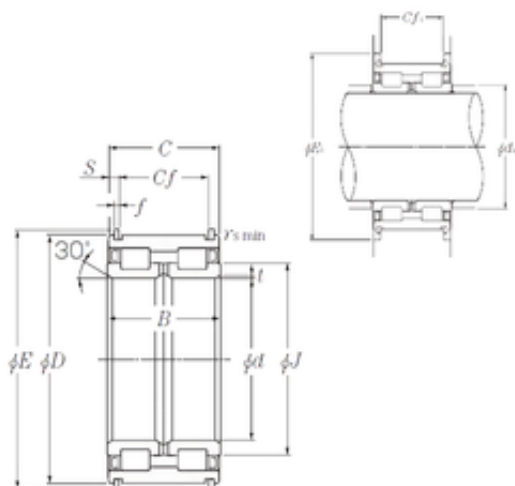

SL04-5080NR NTN Cylindrical Roller Bearing

Bearing No. SL04-5080NR



SL04-5080NR Bearing 2D drawings and 3D CAD models

Size	400x600x272 mm
Bore Diameter	400 mm
Outer Diameter	600 mm
Width	272 mm
d	400 mm
D	600 mm
B	272 mm
C	270 mm
E1	675 mm
t	3,5 mm
f	12 mm
r min.	2 mm
E	627 mm
J	470 mm
S	30 mm
da	412 mm
Cf	210 mm
Cf1	210 mm
Weight	281 Kg
Basic dynamic load rating (C)	4 250 kN
Basic static load rating (C0)	9 950 kN