

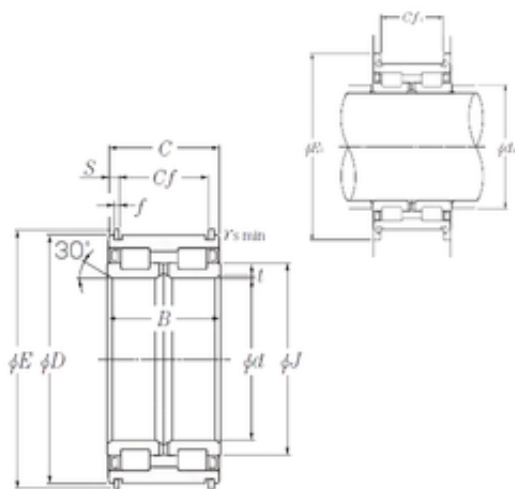

SL04-5068NR NTN Cylindrical Roller Bearing

Bearing No. SL04-5068NR



SL04-5068NR Bearing 2D drawings and 3D CAD models

Size	340x520x243 mm
Bore Diameter	340 mm
Outer Diameter	520 mm
Width	243 mm
d	340 mm
D	520 mm
B	243 mm
C	241 mm
E1	580 mm
t	3,5 mm
f	8 mm
r min.	2 mm
E	545 mm
J	406 mm
S	23,5 mm
da	352 mm
Cf	194 mm
Cf1	194 mm
Weight	194 Kg
Basic dynamic load rating (C)	3 650 kN
Basic static load rating (C0)	8 000 kN