

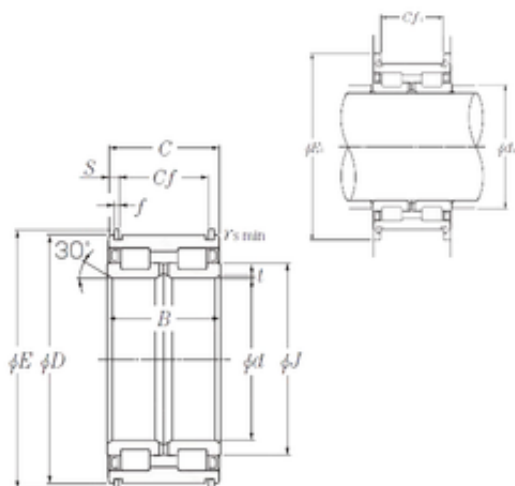

SL04-5064NR NTN Cylindrical Roller Bearing

Bearing No. SL04-5064NR



SL04-5064NR Bearing 2D drawings and 3D CAD models

Size	320x480x218 mm
Bore Diameter	320 mm
Outer Diameter	480 mm
Width	218 mm
d	320 mm
D	480 mm
B	218 mm
C	216 mm
E1	530 mm
t	3 mm
f	8 mm
r min.	1,5 mm
E	501 mm
J	376 mm
S	20 mm
da	330 mm
Cf	176 mm
Cf1	176 mm
Weight	144 Kg
Basic dynamic load rating (C)	2 720 kN
Basic static load rating (C0)	6 100 kN