

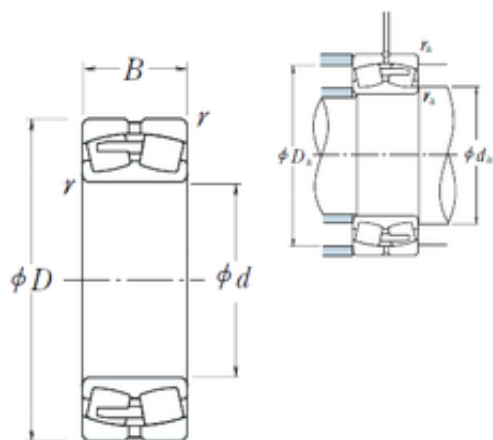

240/1180CAE4 NSK Spherical Roller Bearing



Bearing No. 240/1180CAE4

Size	1180x1660x475 mm
Bore Diameter	1180 mm
Outer Diameter	1660 mm
Width	475 mm
d	1180 mm
D	1660 mm
B	475 mm
C	475 mm
r min.	9,5 mm
da min.	1224 mm
Da min	1494 mm
Da max.	1616 mm
ra max.	8 mm
Weight	3180 Kg
Basic dynamic load rating (C)	20200 kN
Basic static load rating (C0)	52500 kN
(Grease) Lubrication Speed	85 r/min
(Oil) Lubrication Speed	110 r/min
Calculation factor (e)	0,27
Calculation factor (Y0)	2,4
Calculation factor (Y2)	3,7

240/1180CAE4 Bearing 2D drawings and 3D CAD models