

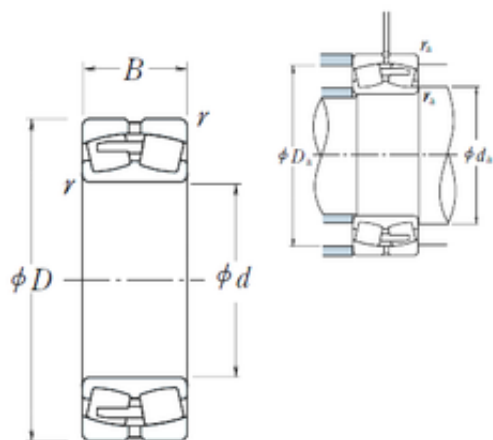

240/1120CAE4 NSK Spherical Roller Bearing



Bearing No. 240/1120CAE4

Size	1120x1580x462 mm
Bore Diameter	1120 mm
Outer Diameter	1580 mm
Width	462 mm
d	1120 mm
D	1580 mm
B	462 mm
C	462 mm
r min.	9,5 mm
da min.	1164 mm
Da min	1421 mm
Da max.	1536 mm
ra max.	8 mm
Weight	2790 Kg
Basic dynamic load rating (C)	18700 kN
Basic static load rating (C0)	49500 kN
(Grease) Lubrication Speed	95 r/min
(Oil) Lubrication Speed	120 r/min
Calculation factor (e)	0,27
Calculation factor (Y0)	2,5
Calculation factor (Y2)	3,7

240/1120CAE4 Bearing 2D drawings and 3D CAD models