

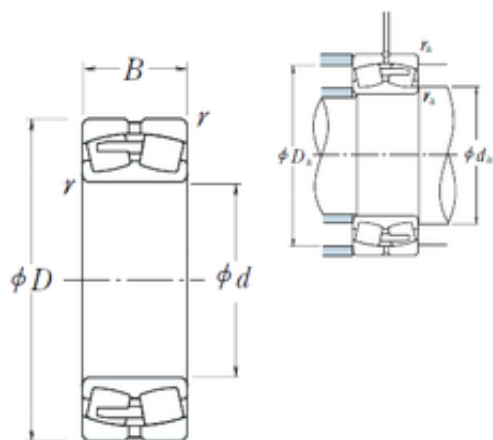

240/1060CAE4 NSK Spherical Roller Bearing



Bearing No. 240/1060CAE4

Size	1060x1500x438 mm
Bore Diameter	1060 mm
Outer Diameter	1500 mm
Width	438 mm
d	1060 mm
D	1500 mm
B	438 mm
C	438 mm
r min.	9,5 mm
da min.	1104 mm
Da min	1346 mm
Da max.	1456 mm
ra max.	8 mm
Weight	2410 Kg
Basic dynamic load rating (C)	16800 kN
Basic static load rating (C0)	43000 kN
(Grease) Lubrication Speed	100 r/min
(Oil) Lubrication Speed	130 r/min
Calculation factor (e)	0,28
Calculation factor (Y0)	2,4
Calculation factor (Y2)	3,6

240/1060CAE4 Bearing 2D drawings and 3D CAD models