

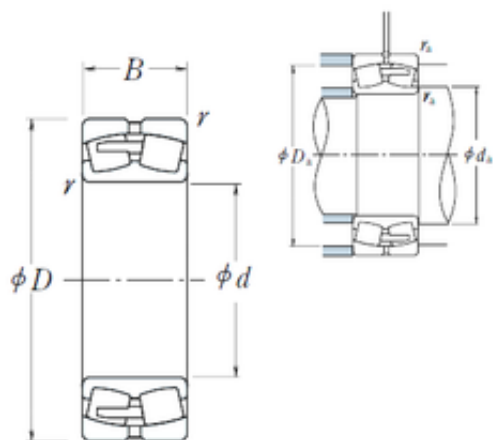

240/670CAE4 NSK Spherical Roller Bearing



Bearing No. 240/670CAE4

Size	670x980x308 mm
Bore Diameter	670 mm
Outer Diameter	980 mm
Width	308 mm
d	670 mm
D	980 mm
B	308 mm
C	308 mm
r min.	7,5 mm
da min.	706 mm
Da min	868 mm
Da max.	944 mm
ra max.	6 mm
Weight	773 Kg
Basic dynamic load rating (C)	8450 kN
Basic static load rating (C0)	19500 kN
(Grease) Lubrication Speed	200 r/min
(Oil) Lubrication Speed	260 r/min
Calculation factor (e)	0,3
Calculation factor (Y0)	2,2
Calculation factor (Y2)	3,3

240/670CAE4 Bearing 2D drawings and 3D CAD models