

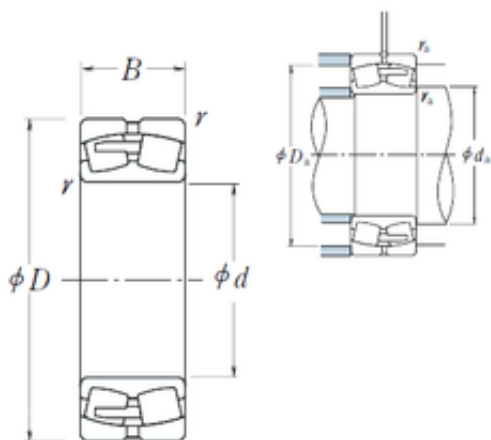

240/630CAE4 NSK Spherical Roller Bearing



Bearing No. 240/630CAE4

Size	630x920x290 mm
Bore Diameter	630 mm
Outer Diameter	920 mm
Width	290 mm
d	630 mm
D	920 mm
B	290 mm
C	290 mm
r min.	7,5 mm
da min.	666 mm
Da min	815 mm
Da max.	884 mm
ra max.	6 mm
Weight	637 Kg
Basic dynamic load rating (C)	7550 kN
Basic static load rating (C0)	17700 kN
(Grease) Lubrication Speed	220 r/min
(Oil) Lubrication Speed	300 r/min
Calculation factor (e)	0,3
Calculation factor (Y0)	2,2
Calculation factor (Y2)	3,3

240/630CAE4 Bearing 2D drawings and 3D CAD models